

S6

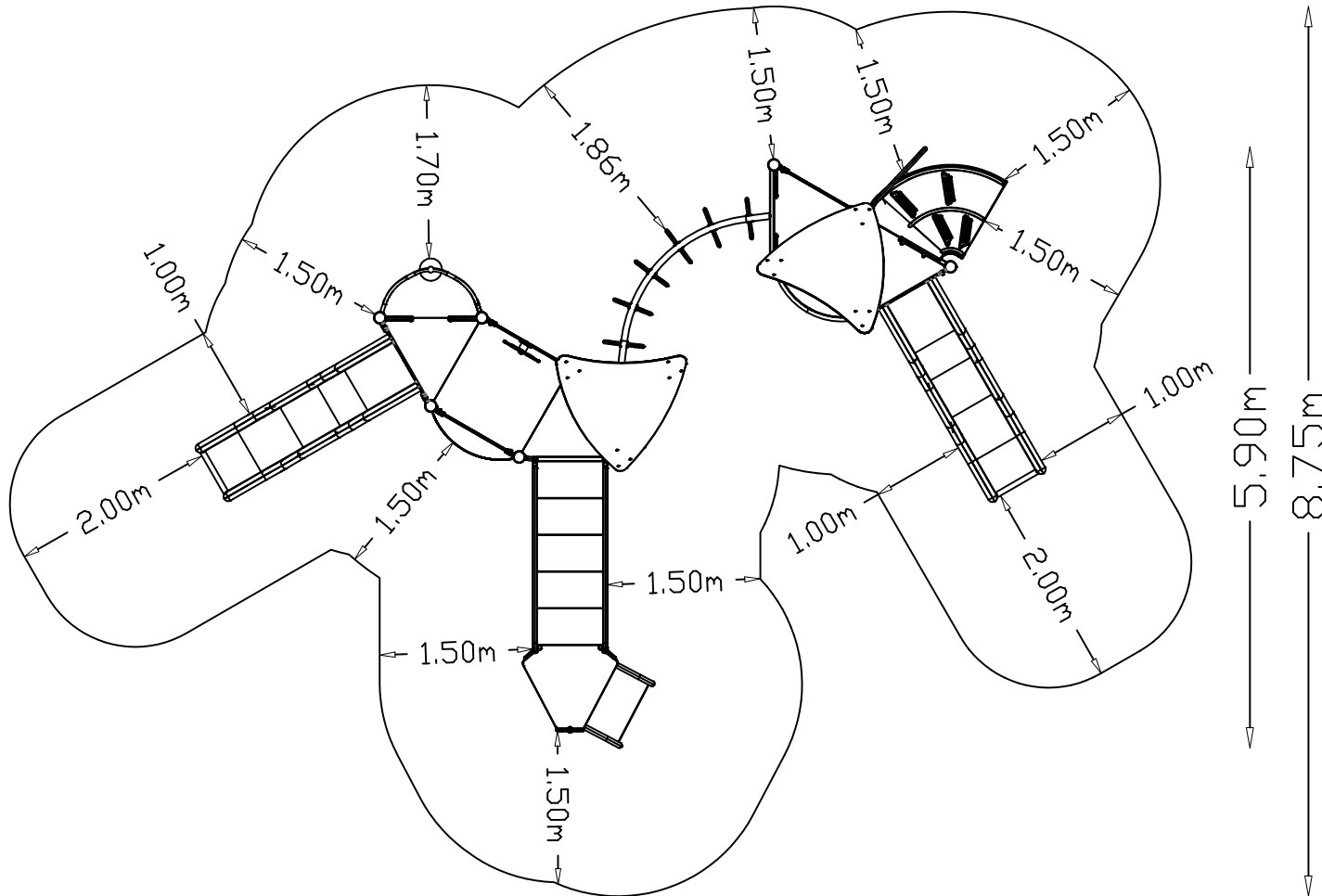

EN1176  
1.96m

# EN1176

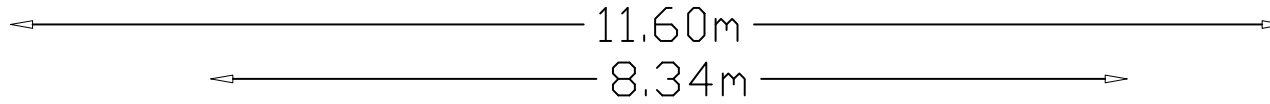

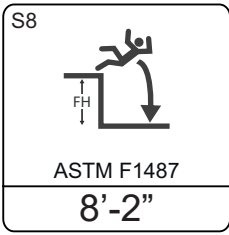

# ASTM F1487

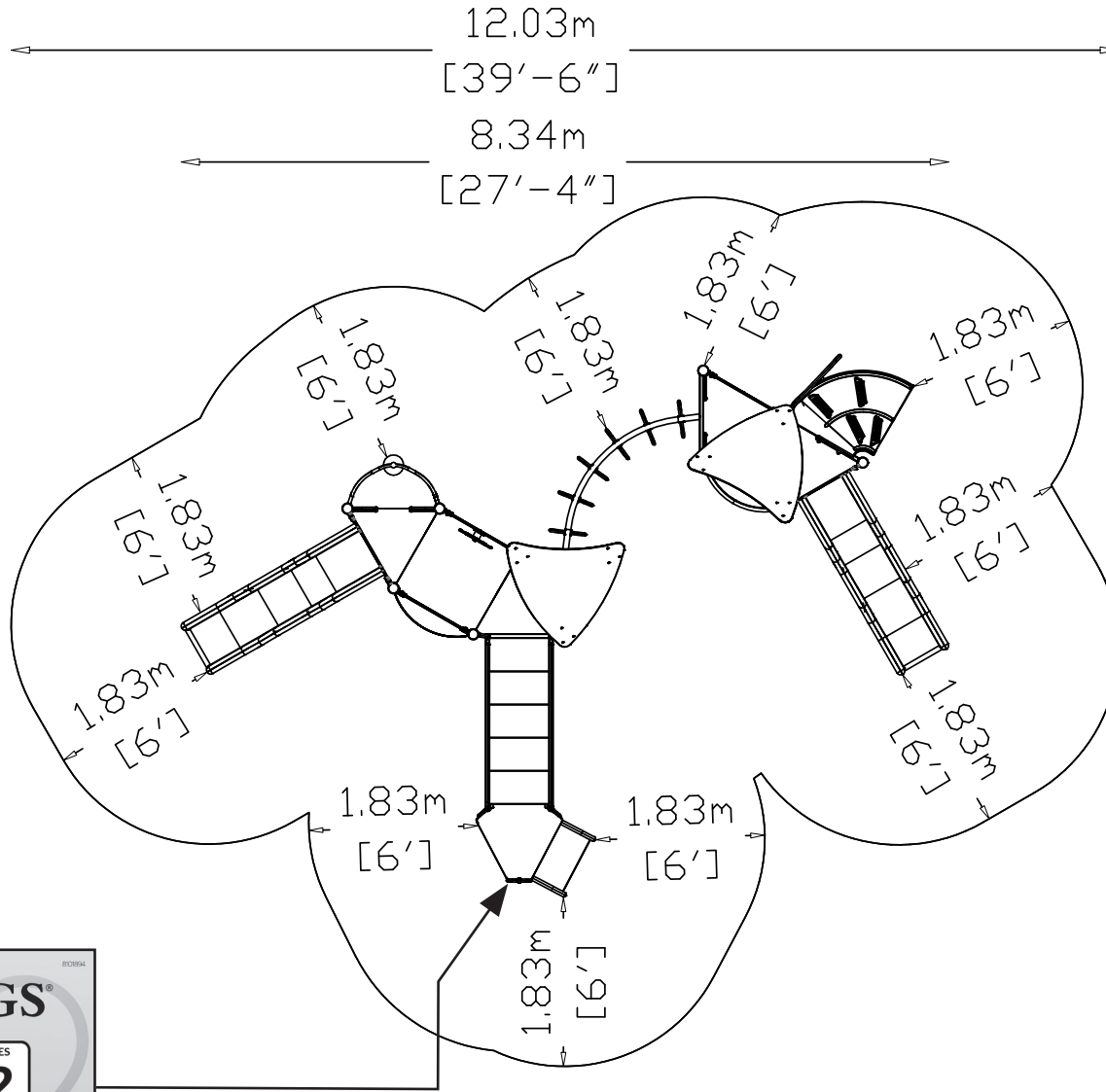



INSTALL  
101

<p><b>WARNING</b></p> <p>Playground equipment installed on hard surfaces may be extremely slippery to children with feet. Always ensure proper footwear is worn. Check for wet surfaces before allowing children to play.</p>	<p><b>WARNING</b></p> <p>Children are capable of climbing and falling through openings. Before allowing children to play, ensure all openings are closed.</p>
<p><b>WARNING</b></p> <p>Children are capable of climbing and falling through openings. Before allowing children to play, ensure all openings are closed.</p>	<p><b>WARNING</b></p> <p>All playground equipment and rubber surfacing should be inspected for loose debris. Check for hot surfaces before allowing children to play. Children should wear appropriate shoes at all times.</p>
<p><b>WARNING</b></p> <p>Playground equipment may be used by children who are not intended to use it. Do not allow children to play on playground equipment if it is damaged or if any parts are missing.</p>	<p><b>WARNING</b></p> <p>Children are capable of climbing and falling through openings. Before allowing children to play, ensure all openings are closed.</p>

5.90m [19'-4"]

9.45m [31']



HAGS®

FOR KIDS AGES

5-12

YEARS

ADULT SUPERVISION RECOMMENDED

www.hags.com



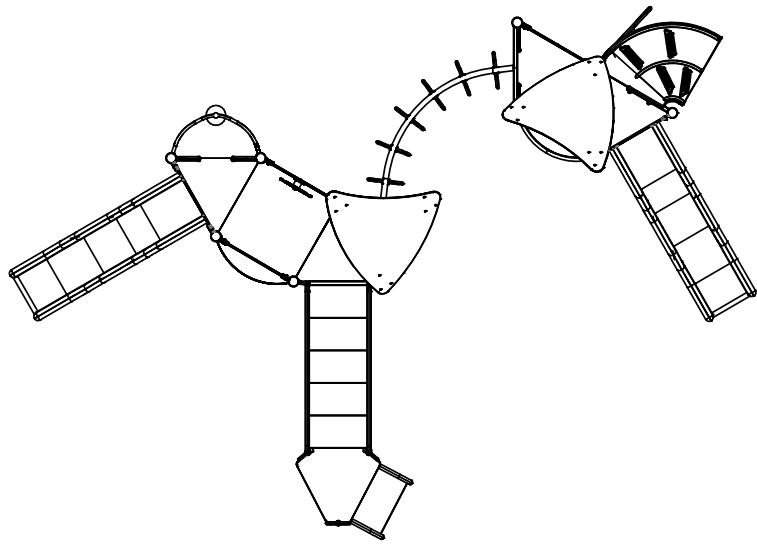

441000

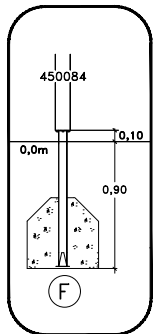
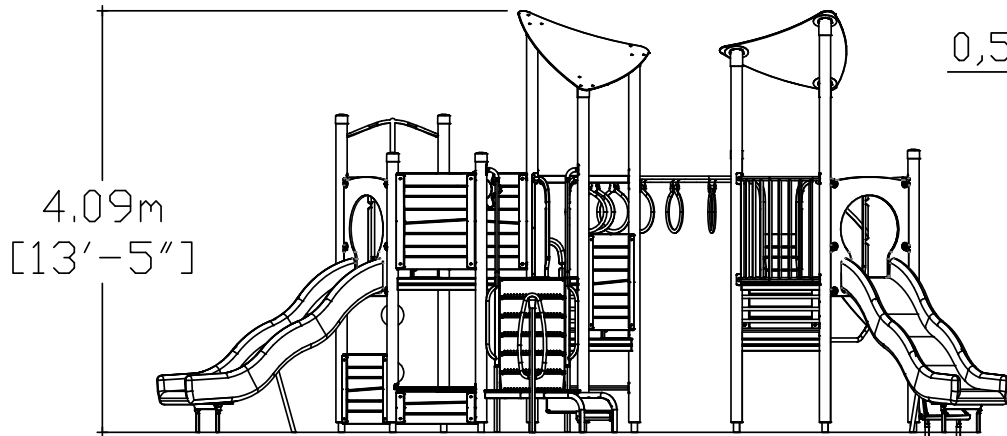
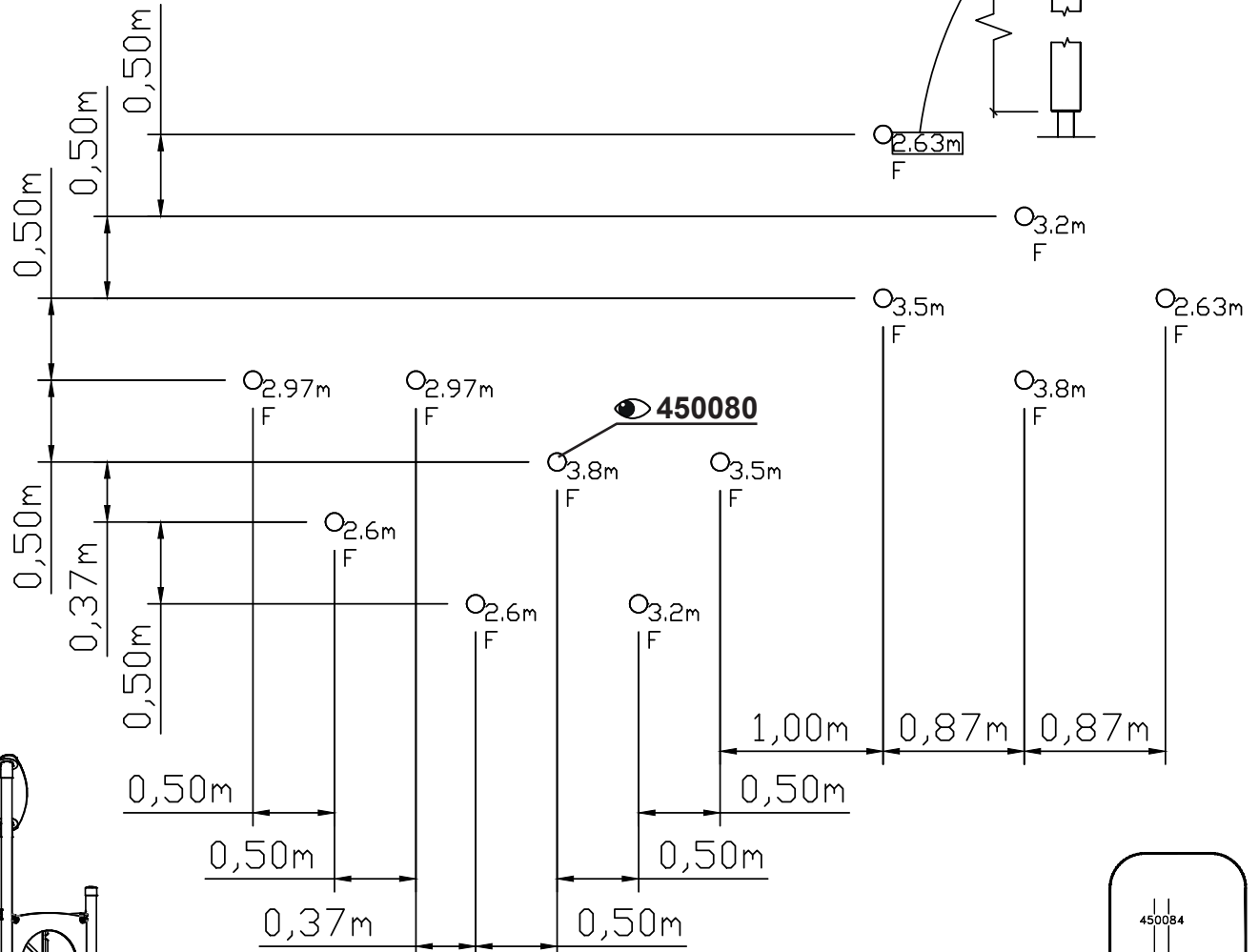
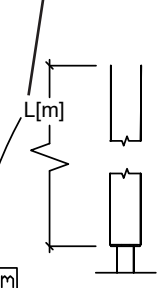

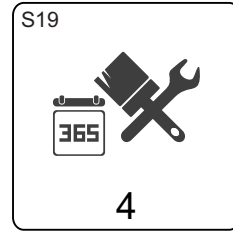
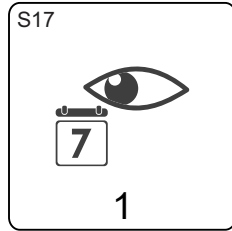
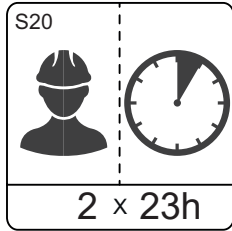
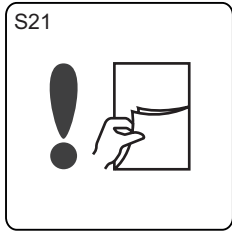

**Install 101**  
**260329**  
**420960**  
**420995**  
**441000**  
**450080**  
**45275323**  
**45475323**  
**MA420U78026**  
**MA422U70010**  
**MA422U77151**  
**MA424U70010**  
**MA424U77151**  
**MA45060523**  
**MASW103874**  
**MASW34156**  
**MASW35156**  
**MASW35330**  
**MASW37573**  
**MASW38904**  
**MASW41284**  
**MASW53817**  
**MASW63820**  
**MASW85869**  
**ST4203**

450080

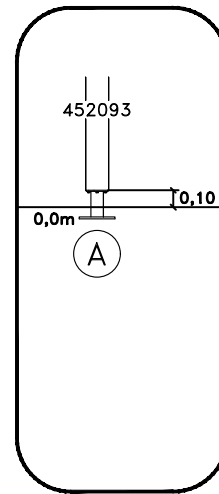

**Above Ground**  
**OM**

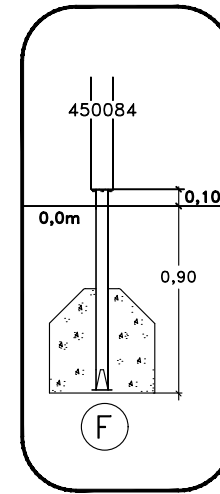

**Cast Loose Fill**  
**BM**  
8102044

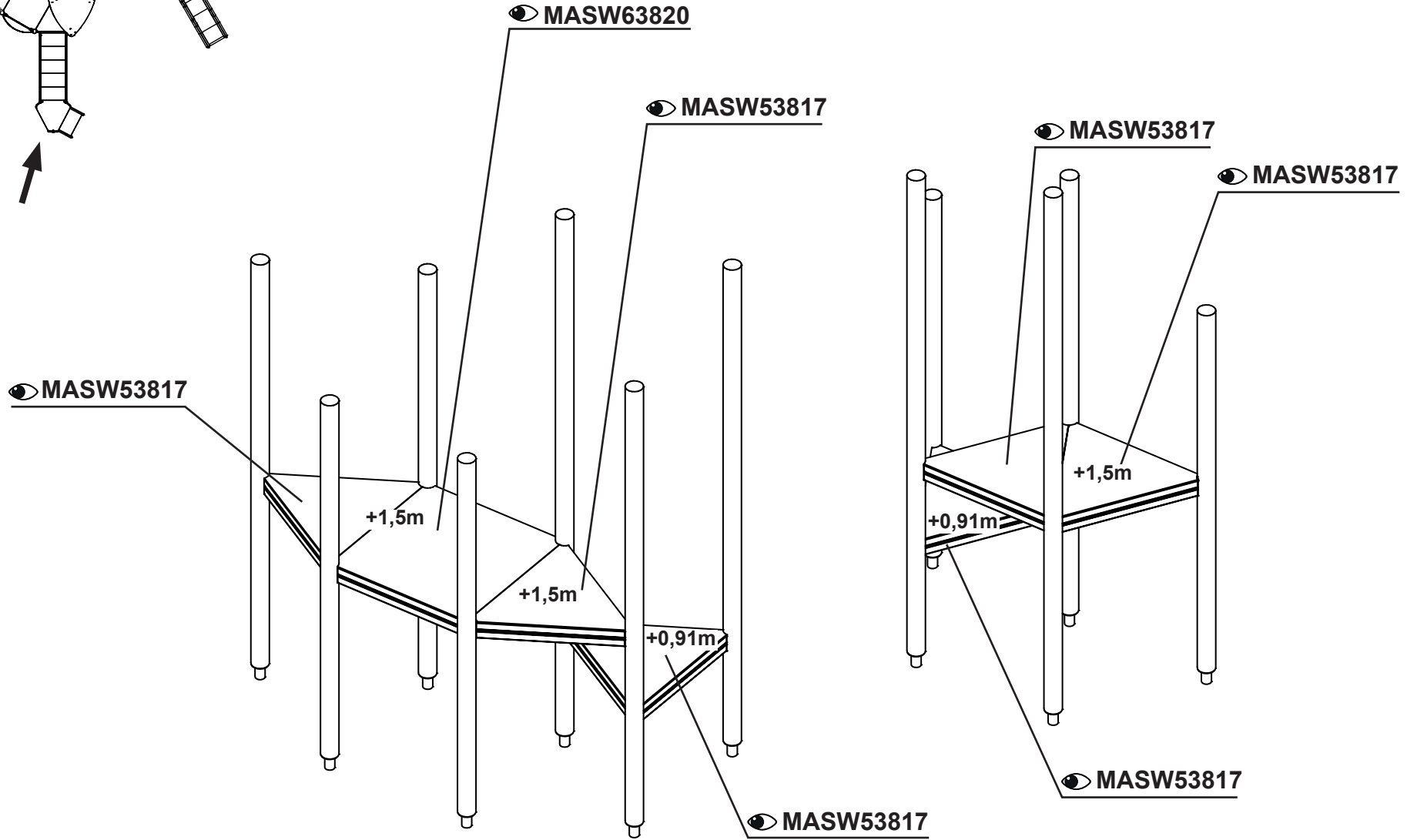
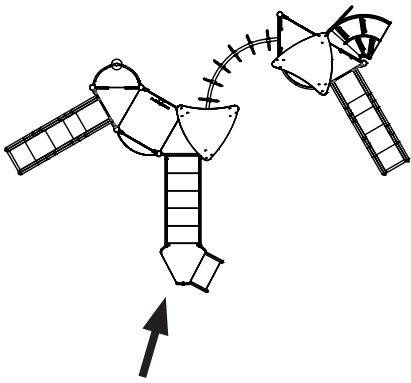

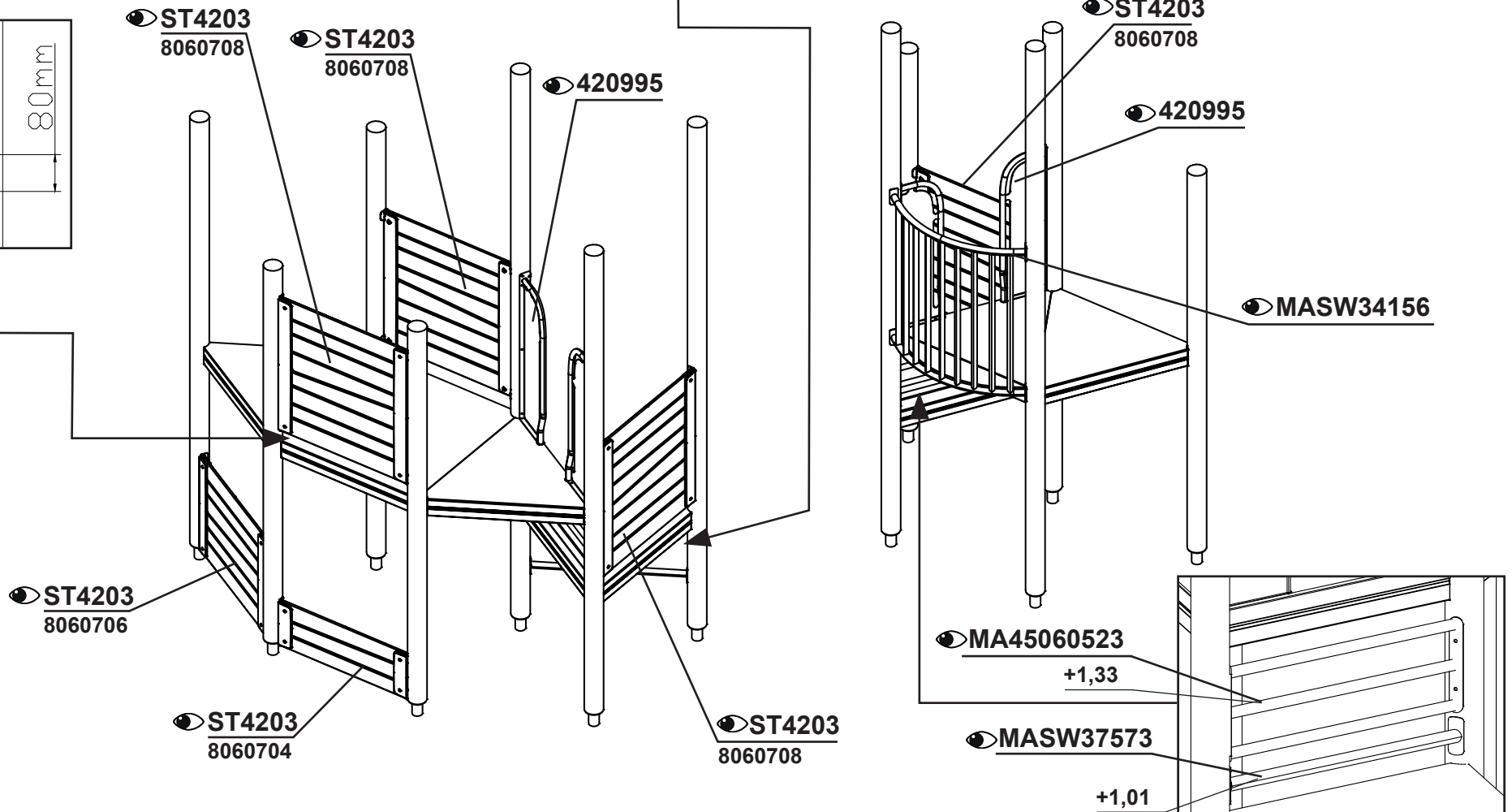
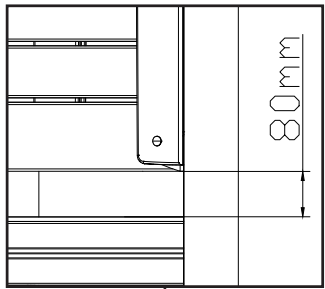
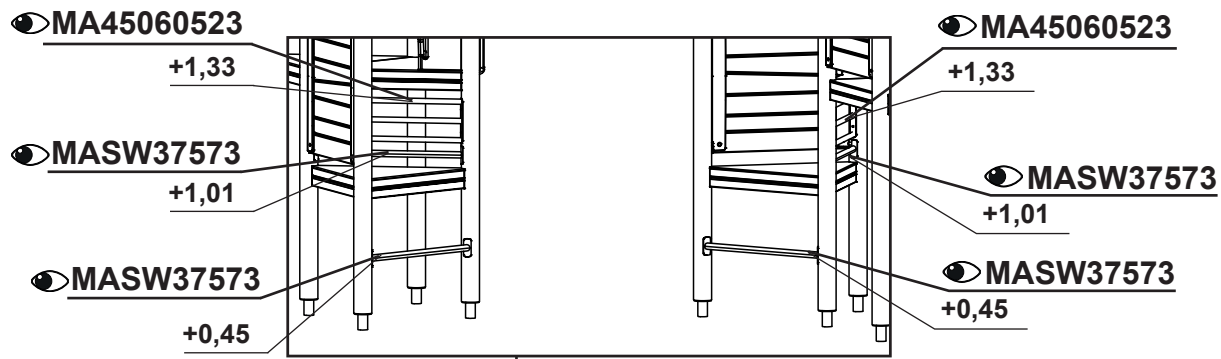
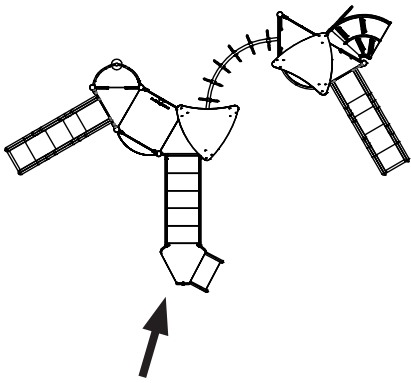



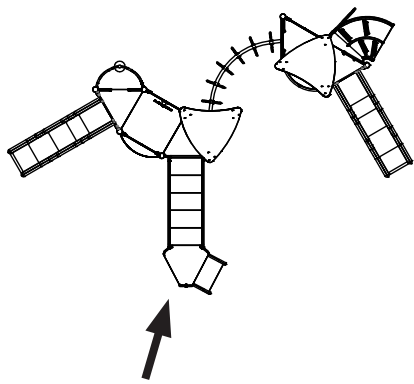

● **MA424U77151** [BM]

● **MA422U77151** [OM]

● **MASW35156**

+1,96m

● **MA420U78026**

● **420960**

● **MASW35330**

● **MA424U70010** [BM]

● **MA422U70010** [OM]

● **45475323** [BM]

● **45275323** [OM]

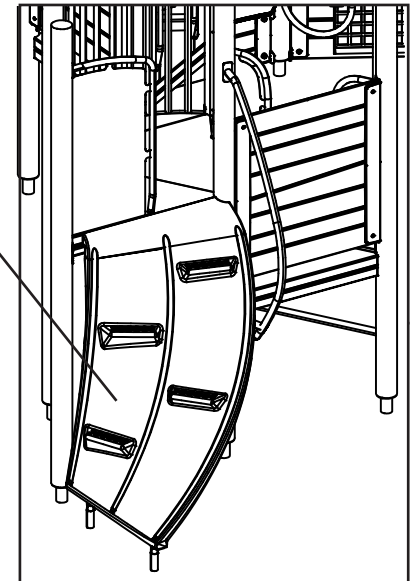
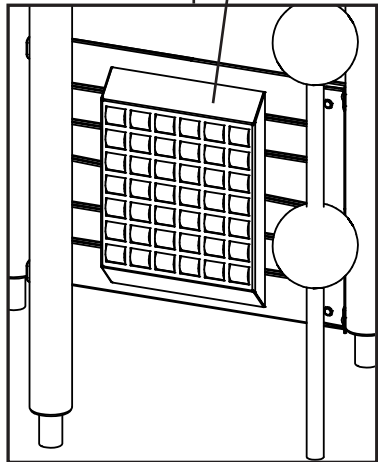

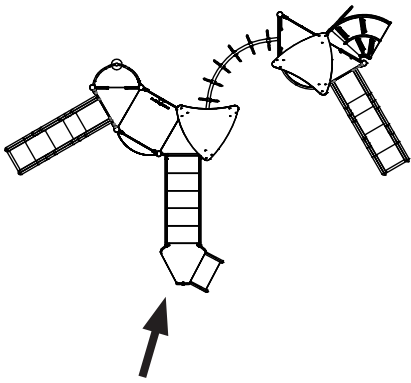

● MASW38904

● MASW38904

● MASW41284

x6

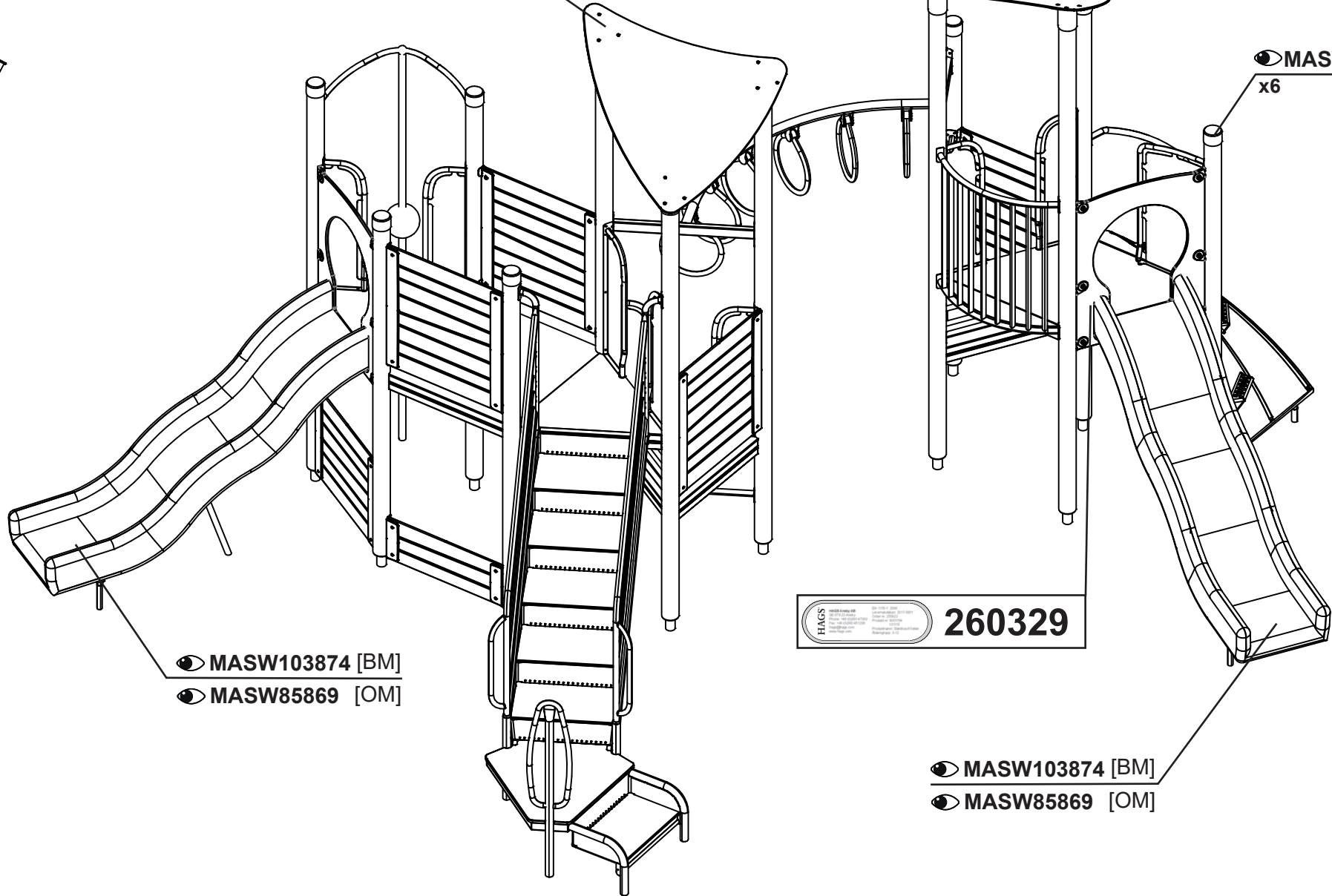

● MASW103874 [BM]

● MASW85869 [OM]



260329

● MASW103874 [BM]

● MASW85869 [OM]